



2022 & 2026 Final LCR Study Results Greater Bay Area

Abhishek Singh

Regional Transmission Engineer Lead

Stakeholder Call

April 7, 2021

Greater Bay Area Transmission System & LCR Subareas

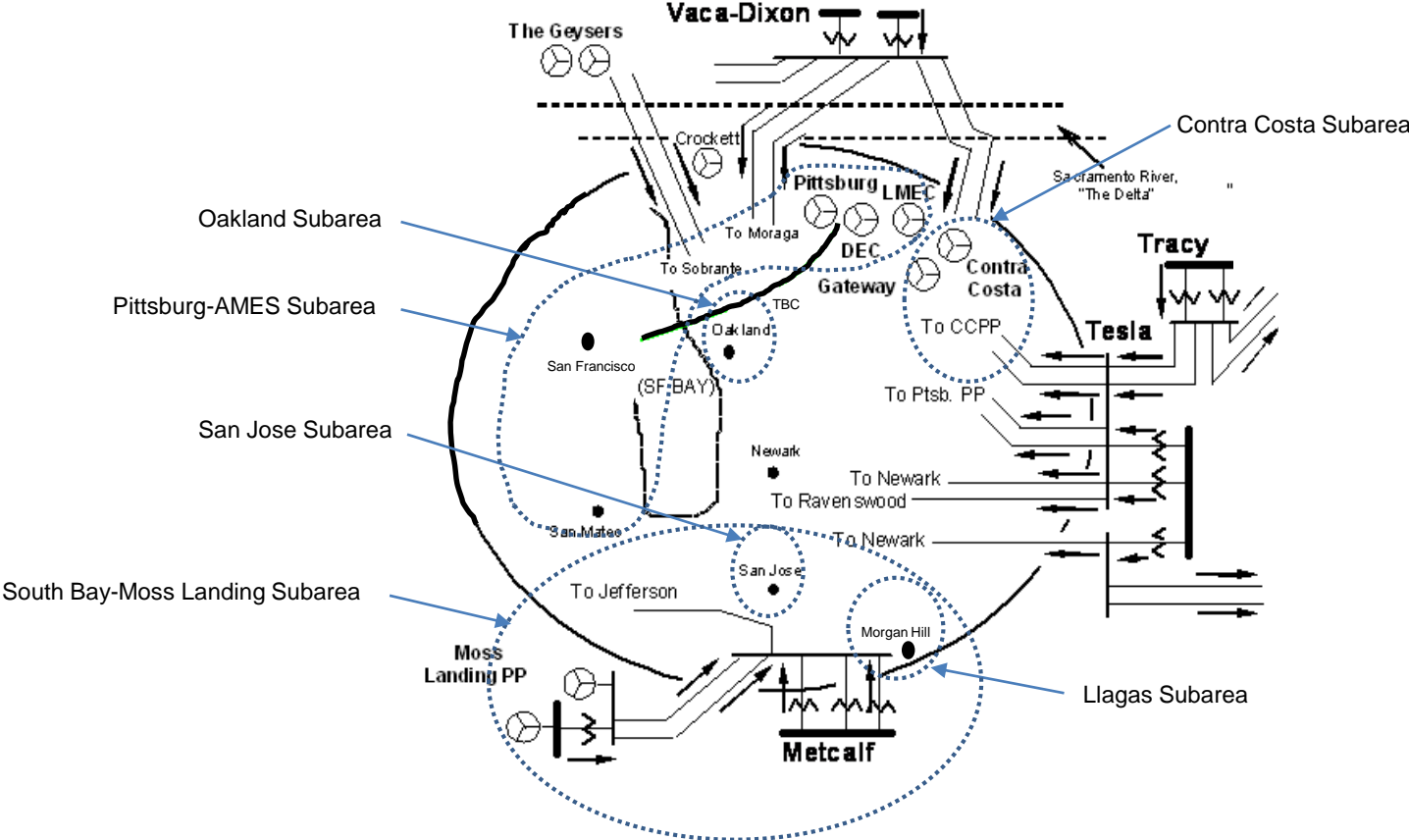

New major transmission projects

Project Name	Expected ISD
East Shore-Oakland J 115 kV Reconductoring Project	May-22
Cooley Landing-Palo Alto and Ravenswood-Cooley Landing 115 kV Line Rerate	Feb-22
Oakland Clean Energy Initiative Project	Aug-22
Morgan Hill Area Reinforcement (revised scope)	Jun-26
East Shore 230 kV Bus Terminals Reconfiguration	May-26

Power plant changes

Additions:

- OCEI Energy Storage modeled in 2026
- Resolution E-4949 energy storage modeled in 2022 & 2026
- New Energy Storage Project at Pittsburg substation

Retirements:

- All Oakland CTs considered offline in 2026

Llagas Sub-area: Load and Resources

Load (MW)	2022	2026	Generation (MW)	2022	2026
Gross Load	200	208	Market	246	246
AAEE	-2	-2	Wind	0	0
Behind the meter DG	-11	-11	Muni	0	0
Net Load	187	195	QF	0	0
Transmission Losses	1	1	Future preferred resource and energy storage	0	0
Pumps	0	0	Total Qualifying Capacity	246	246
Load + Losses + Pumps	188	196			

Llagas Sub-area: One-line diagram

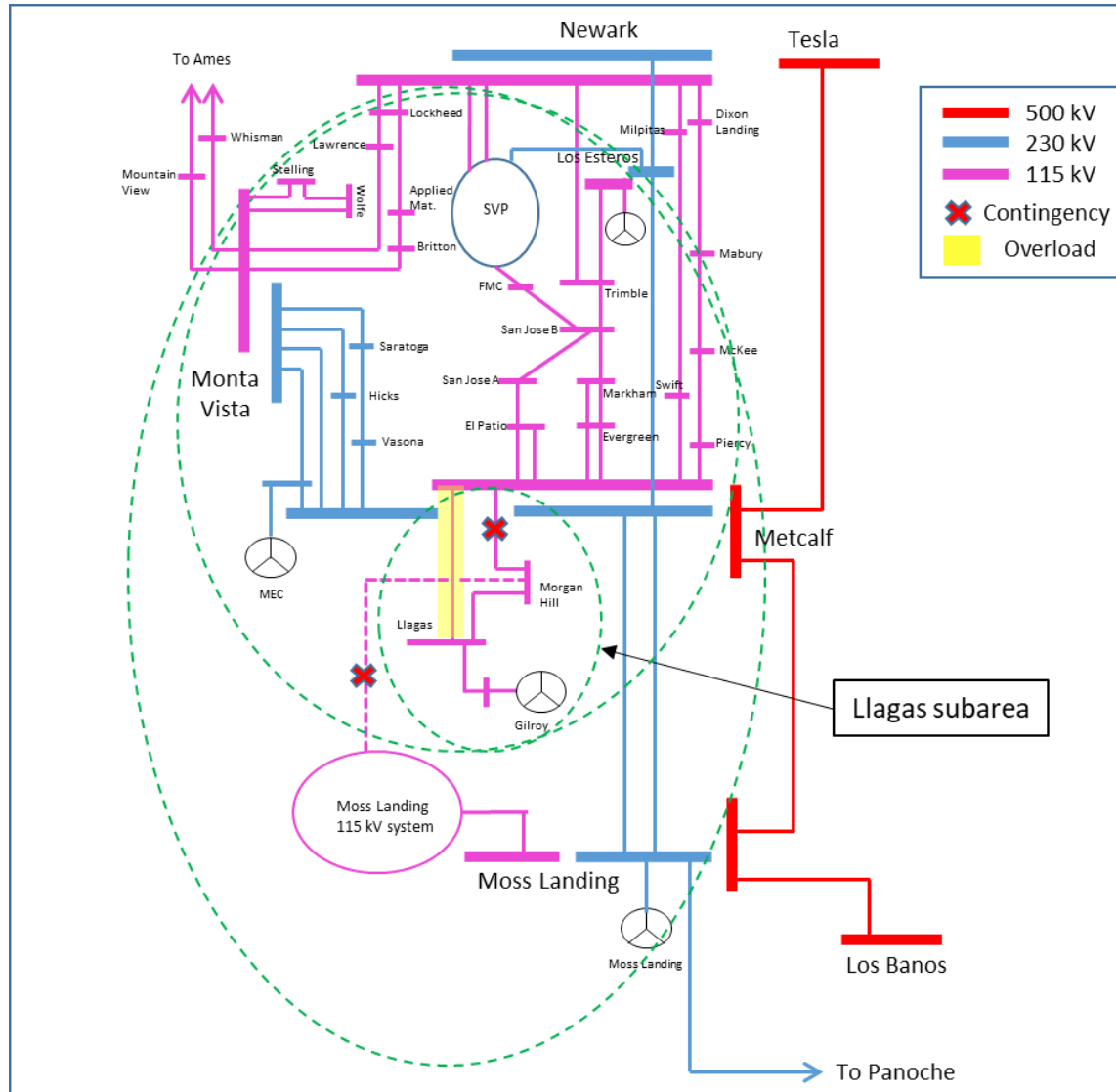

Llagas Sub-area: Requirements

Year	Category	Limiting Facility	Contingency	LCR (MW)
2022	P6	Metcalf-Llagas 115 kV line	Metcalf-Morgan Hill & Morgan Hill-Green Valley 115kV	20
2026	P6	Metcalf-Llagas 115 kV line	Metcalf-Morgan Hill & Morgan Hill-Green Valley 115kV	25

Llagas Sub-area: Load Profiles

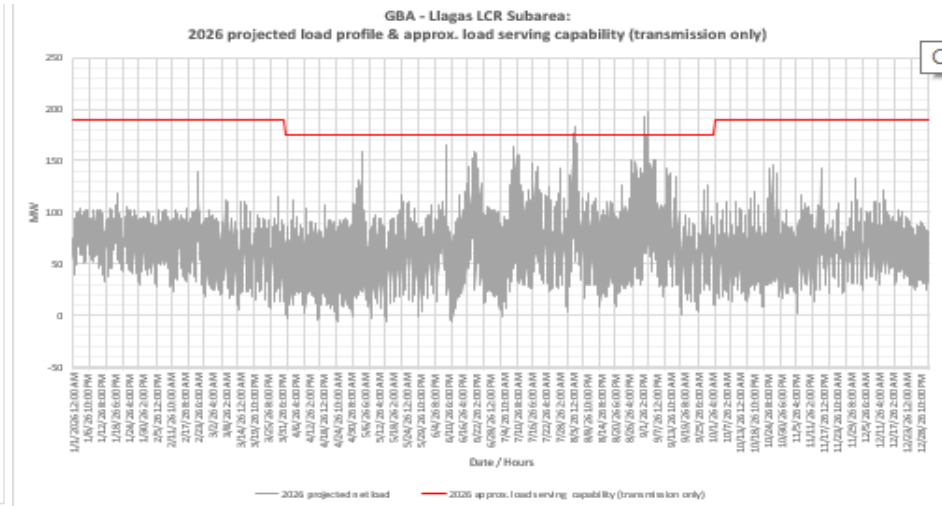
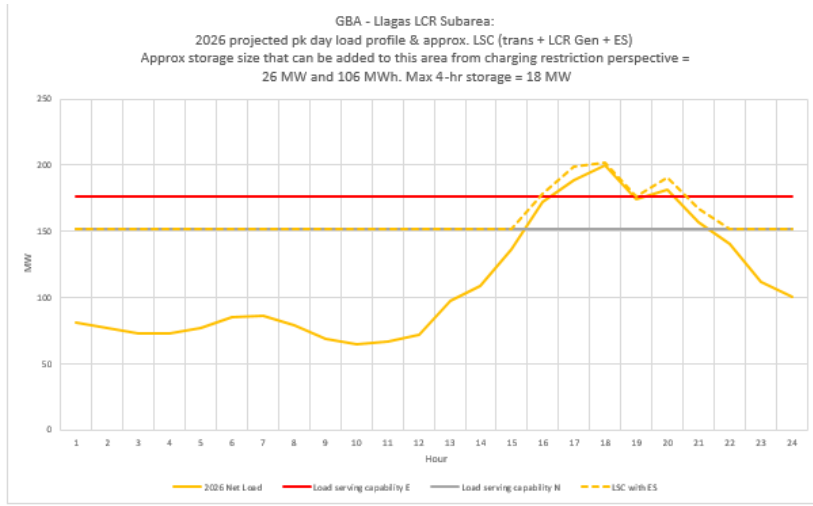
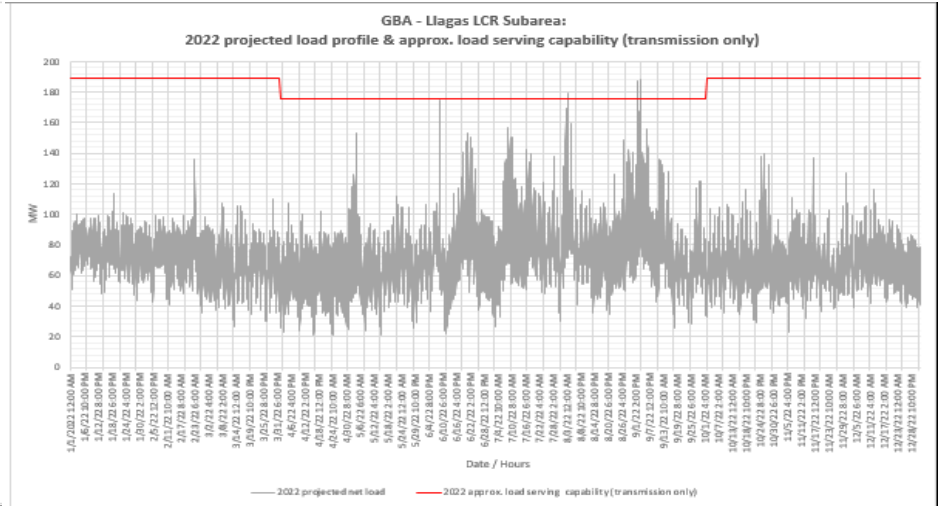
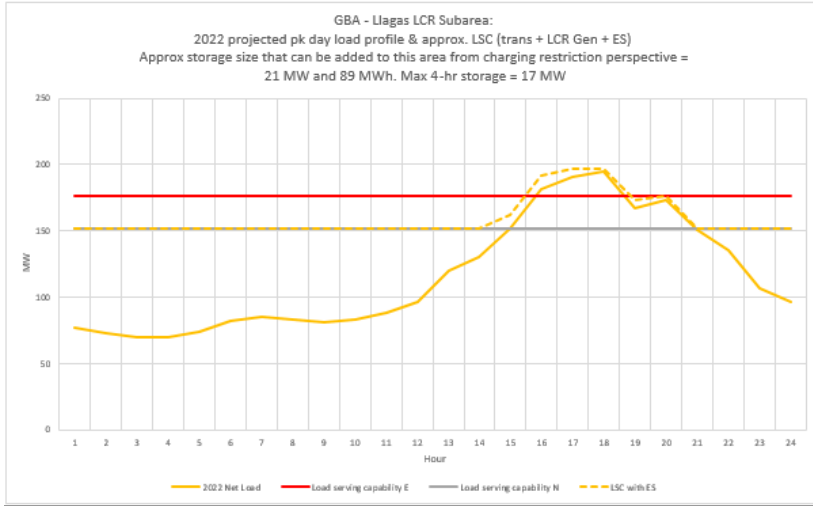

San Jose Sub-area: Load and Resources

Load (MW)	2022	2026	Generation (MW)	2022	2026
Gross Load	2664	3065	Market	575	575
AAEE	-21	-40	Wind	0	0
Behind the meter DG	-56	-57	Muni	198	198
Net Load	2587	2968	QF	0	0
Transmission Losses	95	114	Future preferred resource and energy storage	75	75
Pumps	0	0	Total Qualifying Capacity	848	848
Load + Losses + Pumps	2682	3082			

San Jose Sub-area: One-line diagram

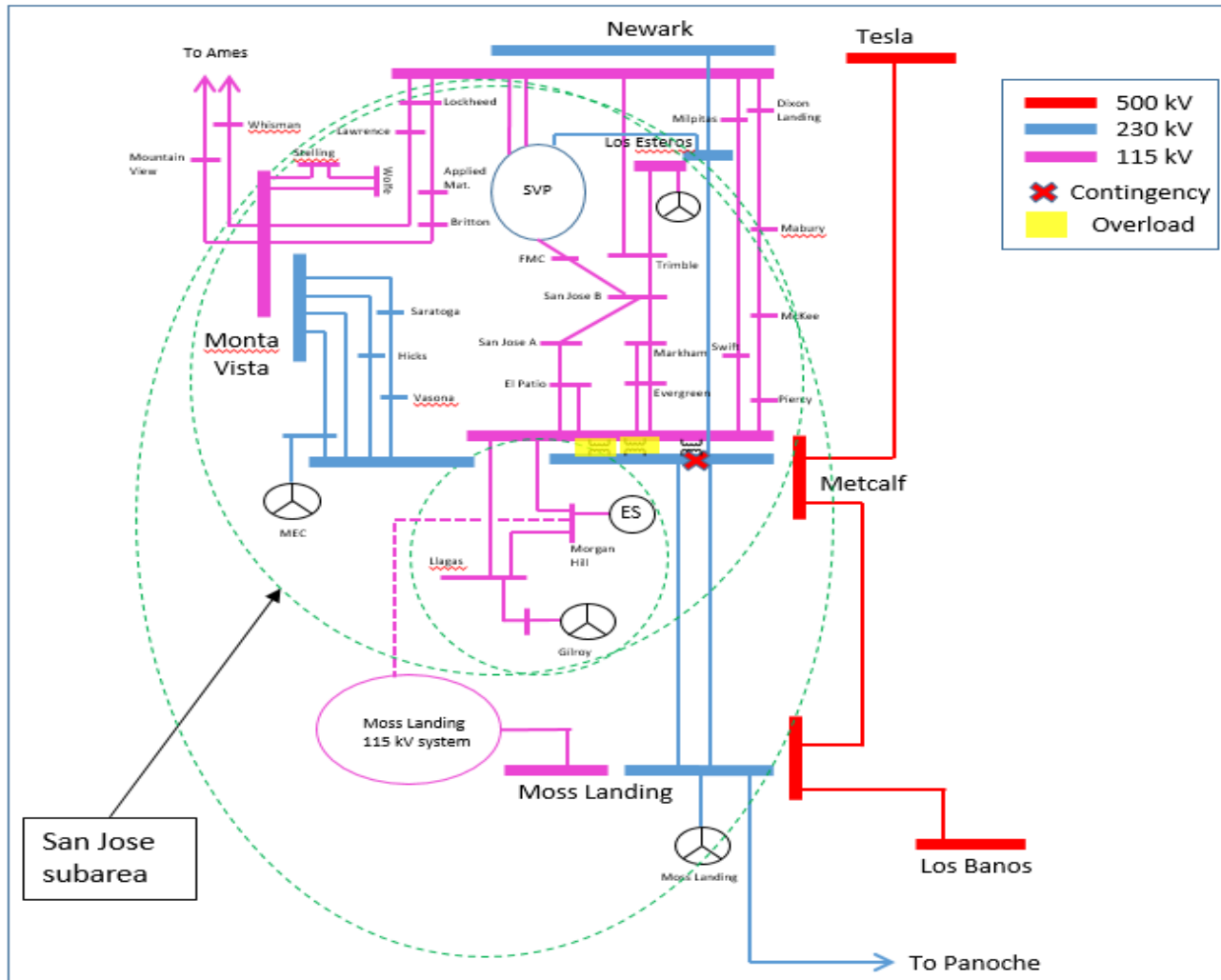

San Jose Sub-area: Requirements

Year	Category	Limiting Facility	Contingency	LCR (MW) (deficiency)
2022	P2-4	Metcalf 230/115 kV transformer # 1 or # 3	METCALF 230kV - Section 2D & 2E	989 (141)
2026	P2-4	Metcalf 230/115 kV transformer # 1 or # 3	METCALF 230kV - Section 2D & 2E	1096 (248)

San Jose Sub-area: Load Profiles

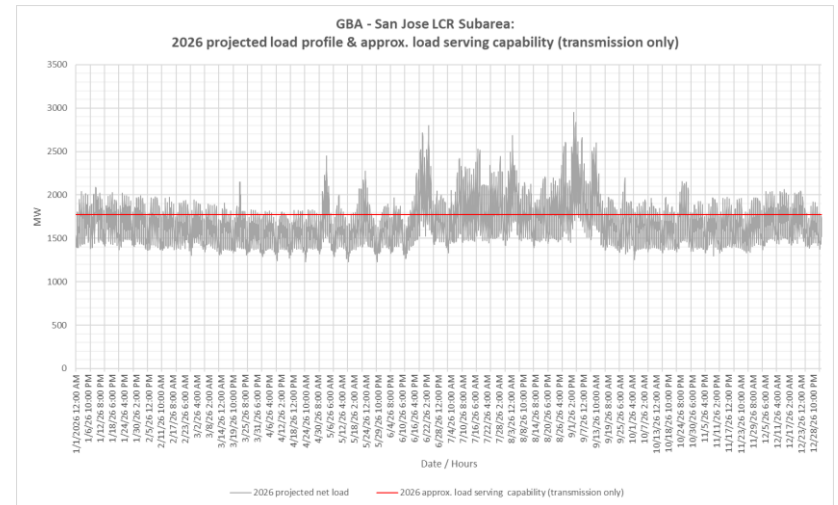
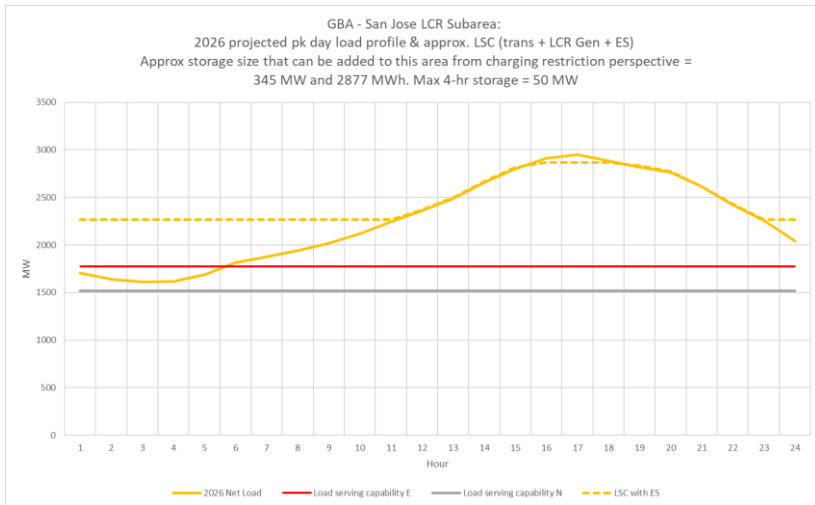
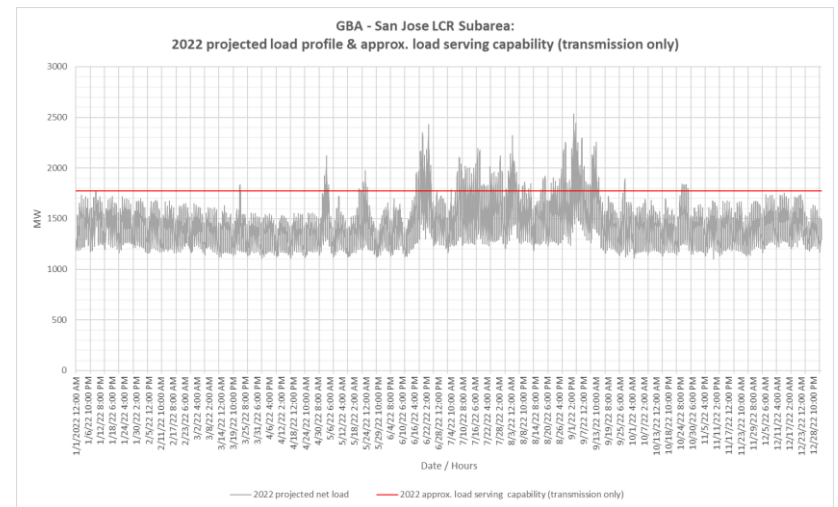
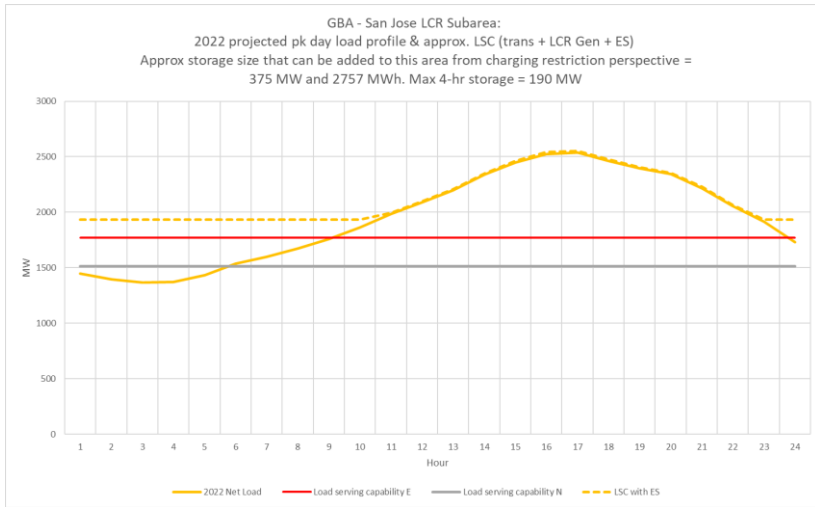

South Bay-Moss Landing Sub-area: Load and Resources

Load (MW)	2022	2026	Generation (MW)	2022	2026
Gross Load	4338	4834	Market	2165	2165
AAEE	-32	-61	Wind	0	0
Behind the meter DG	-112	-107	Muni	198	198
Net Load	4194	4,666	QF	0	0
Transmission Losses	127	143	Future preferred resource and energy storage	658	658
Pumps	0	0	Total Qualifying Capacity	3,021	3,021
Load + Losses + Pumps	4321	4809			

South Bay-Moss Landing Sub-area: One-line diagram

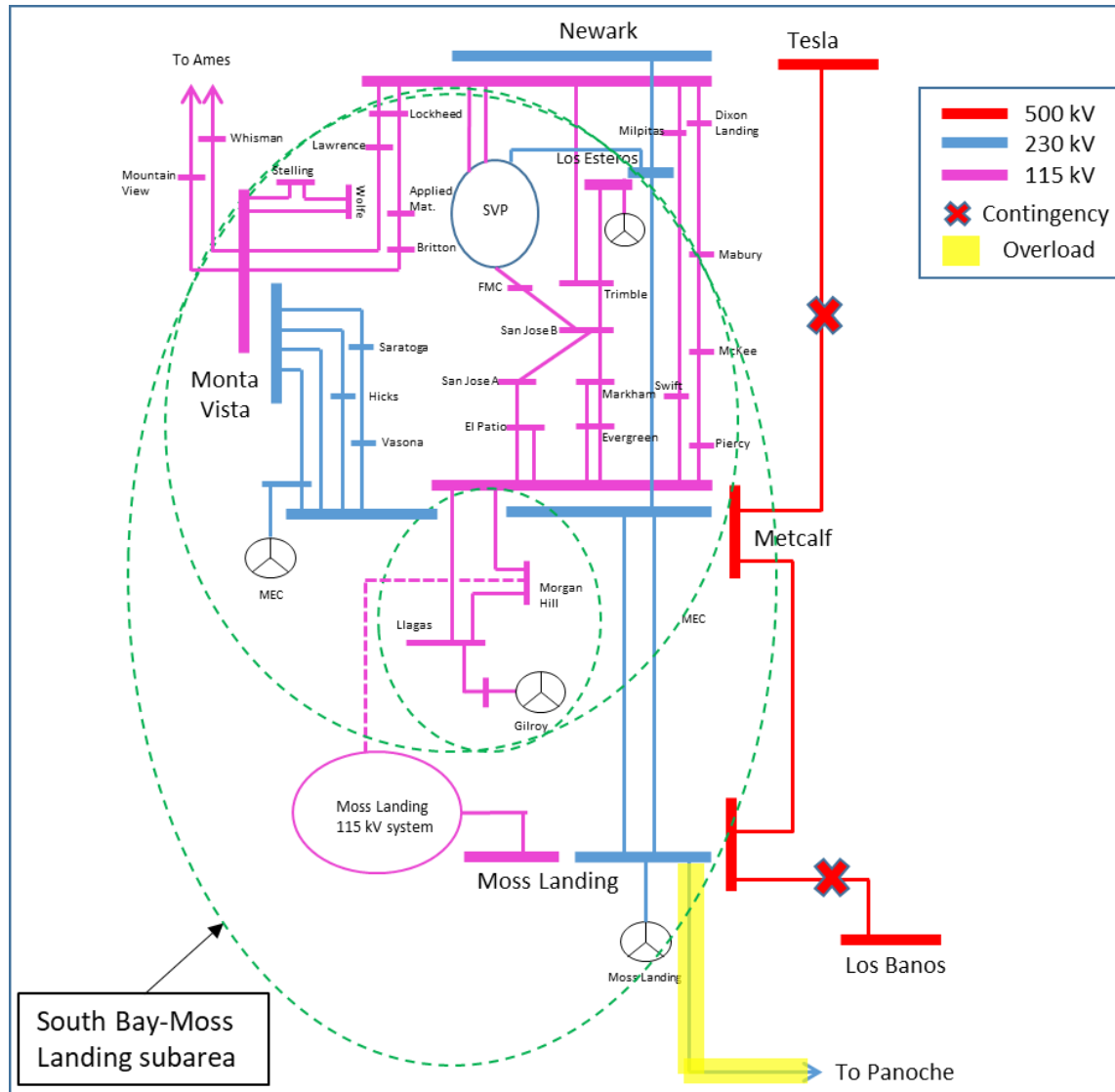

South Bay-Moss Landing Sub-area: Requirements

Year	Category	Limiting Facility	Contingency	LCR (MW)
2022	P6	Moss Landing-Las Aguilas 230 kV	Tesla-Metcalf 500 kV and Moss Landing-Los Banos 500 kV	2333
2026	P6	Moss Landing-Las Aguilas 230 kV	Tesla-Metcalf 500 kV and Moss Landing-Los Banos 500 kV	2535

South Bay-Moss Landing Sub-area: Load Profiles

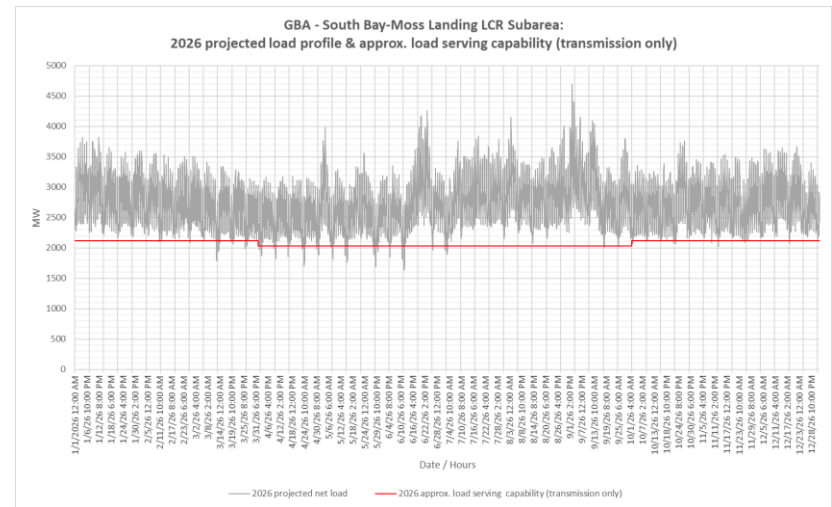
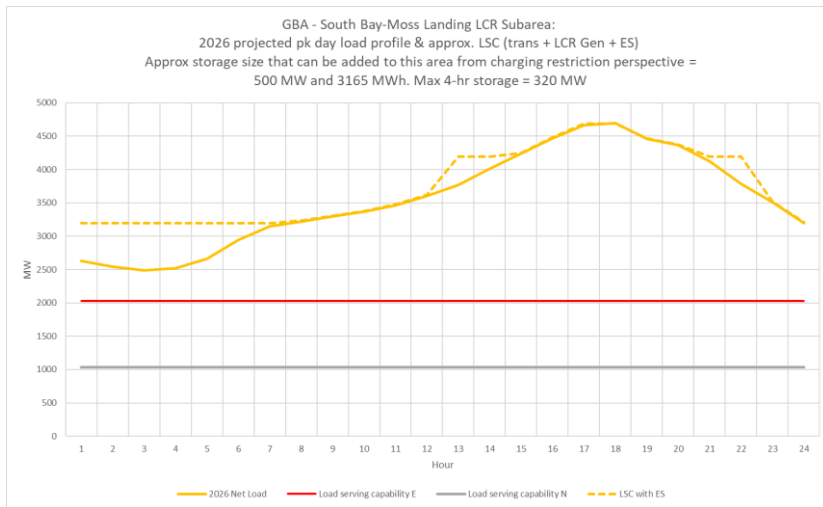
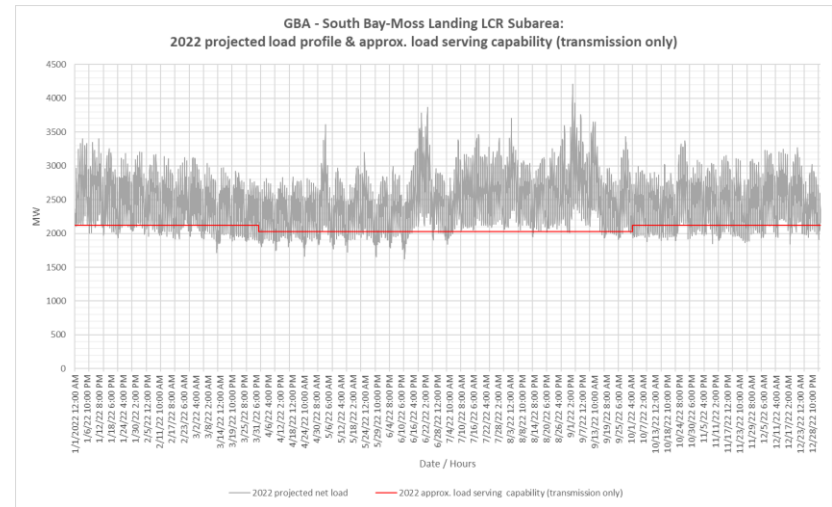
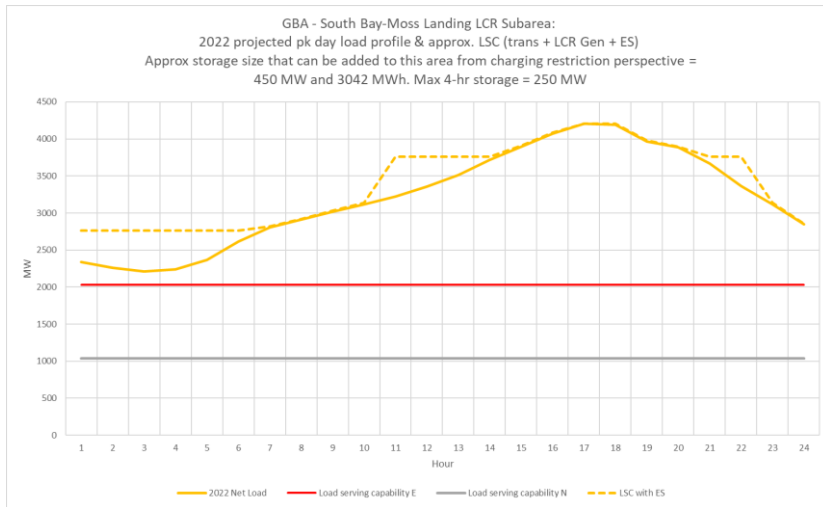

Oakland Sub-area: Load and Resources

Load (MW)	2022	2026	Generation (MW)	2022	2026
Gross Load	184	181	Market	110	0
AAEE	-1	-2	Wind	0	0
Behind the meter DG	-2	-1	Muni	49	49
Net Load	181	178	QF	0	0
Transmission Losses	0	0	Future preferred resource and energy storage	0	36
Pumps	0	0	Total Qualifying Capacity	159	85
Load + Losses + Pumps	181	178			

Oakland Sub-area: Requirements

Year	Category	Limiting Facility	Contingency	LCR (MW)
2022	P2-4	Moraga-Oakland X# 3	Moraga 115kV - Section 1D & 2D	101
2026	P6	Moraga-Claremont #2 115 kV	Oakland C-X #2 & #3 115 kV cables	31*

Note:

*This requirement doesn't reflect potential load transfer that could occur following the first contingency. An approved operating procedure including this load transfer could reduce this requirement.

OCEI is not modeled in 2022 LCR cases

Oakland Sub-area: Load Profiles

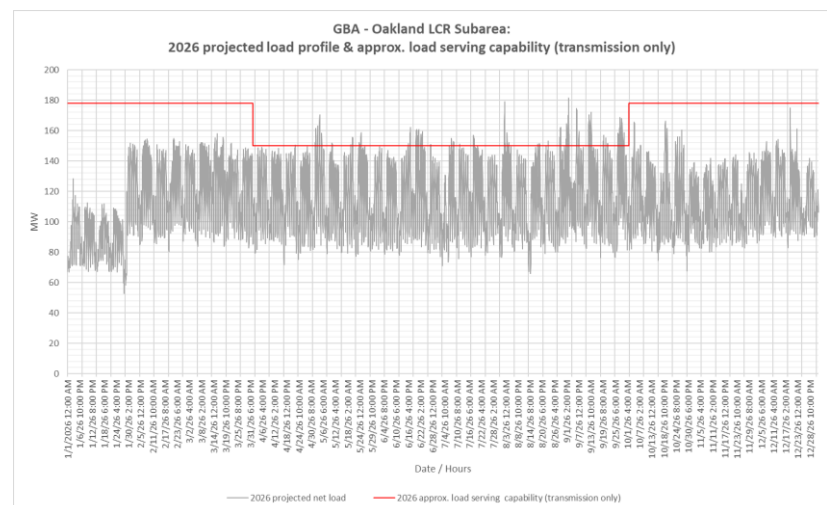
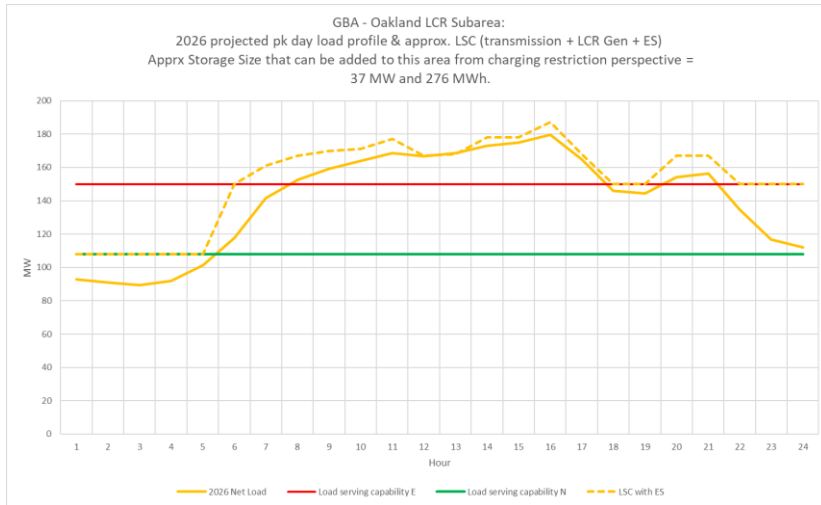
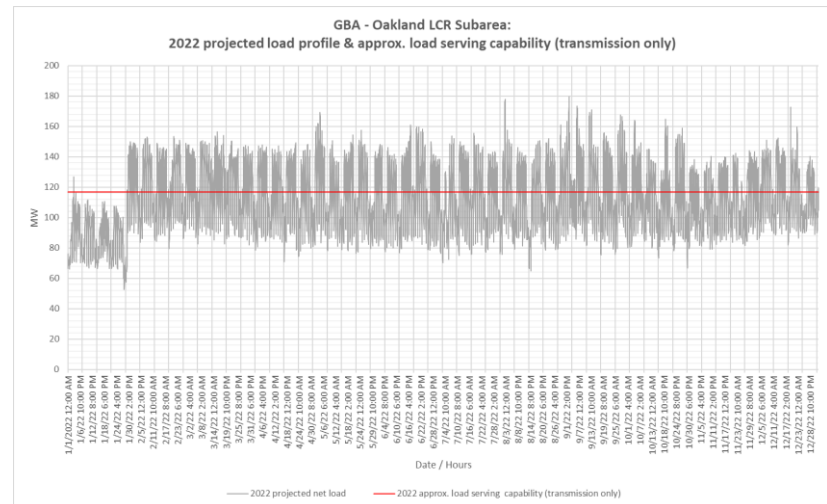
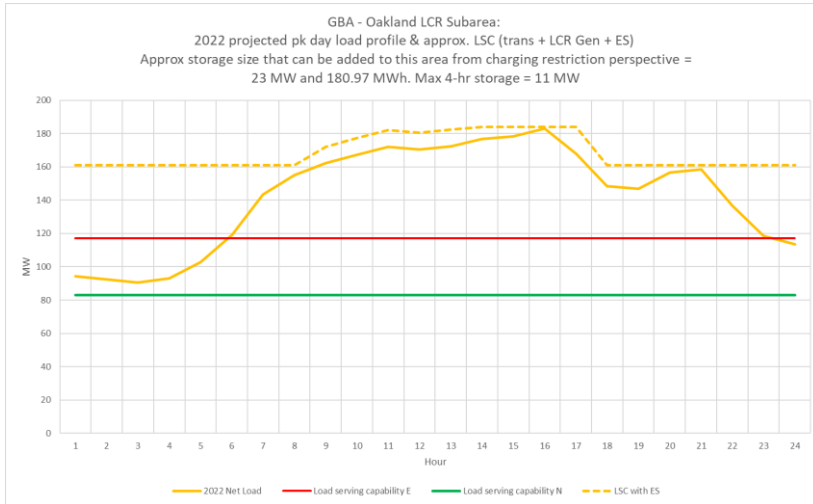

Pittsburg-Ames-Oakland Sub-area: Load and Resources

Load (MW)	2022	2026	Generation (MW)	2022	2026
Gross Load	NA – Flow through area.		Market/ Net Seller / Battery	2379	2284
AAEE			Solar	5	5
Behind the meter DG			Wind	0	0
Net Load			Muni	49	49
Transmission Losses			QF	236	236
Pumps			Future preferred resource and energy storage	0	36
Load + Losses + Pumps			Total Qualifying Capacity	2669	2610

Ames/Pittsburg/Oakland Sub-area: One-line diagram

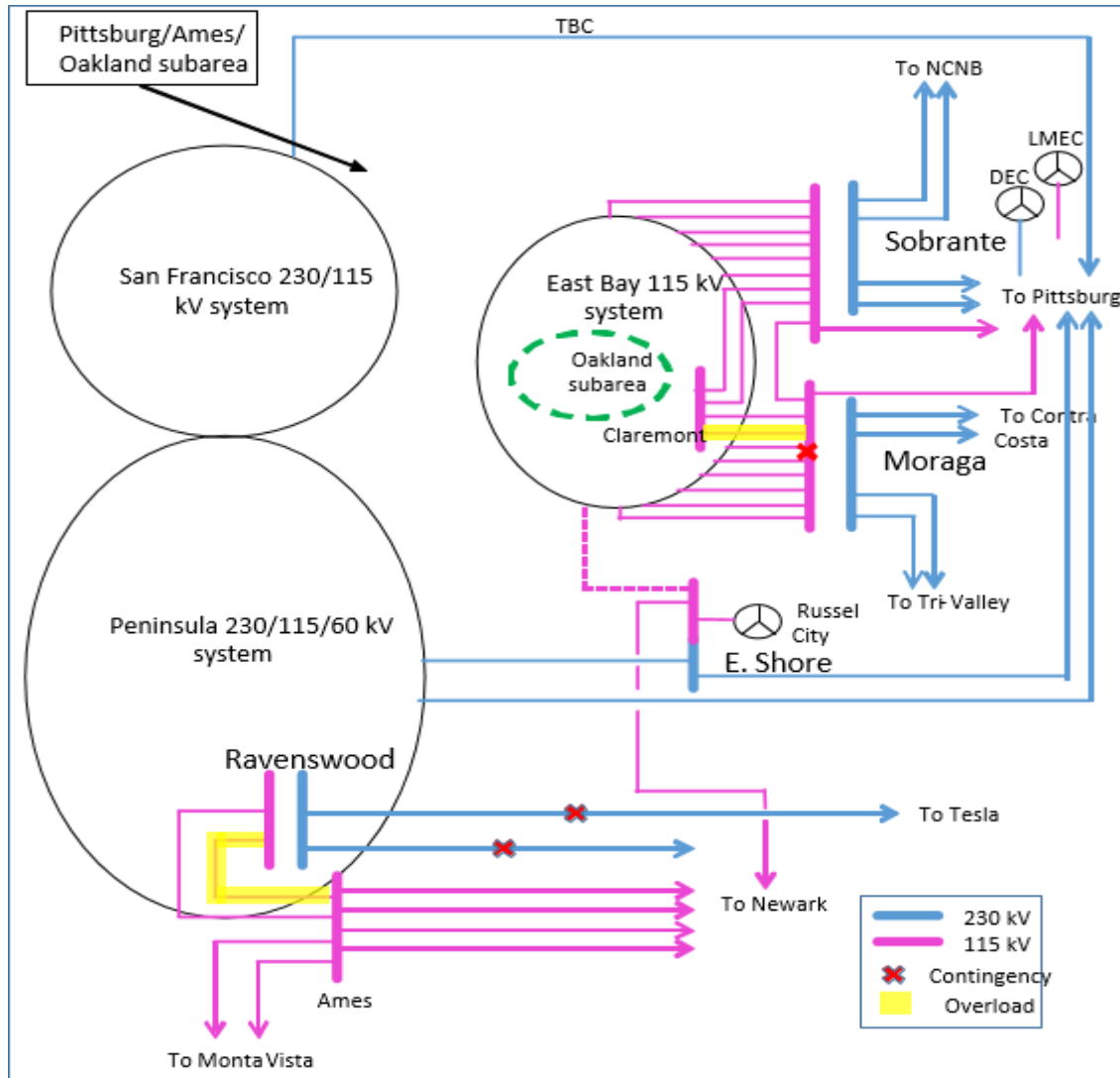

Ames/Pittsburg/Oakland Sub-area: Requirements

Year	Category	Limiting Facility	Contingency	LCR (MW) (Deficiency)
2022	P7	Ames-Ravenswood #1 115 kV line	Newark-Ravenswood & Tesla-Ravenswood 230 kV lines	1791
	P2-4	Moraga-Claremont #2 115 kV line	Moraga 115kV - Section 2D & 2E	
2026	P7	Ames-Ravenswood #1 115 kV line	Newark-Ravenswood & Tesla-Ravenswood 230 kV lines	1763
	P2-4	Oakland C-L	Moraga 115KV - Section 1C & 2C	

Contra Costa Sub-area: Load and Resources

Load (MW)	2022	2026	Generation (MW)	2022	2026
Gross Load	NA – Flow through area.		Market	1674	1674
AAEE			Wind	244	244
Behind the meter DG			Muni	127	127
Net Load			QF	0	0
Transmission Losses			Future preferred resource and energy storage	0	0
Pumps			Total Qualifying Capacity	2,045	2,045
Load + Losses + Pumps					

Contra Costa Sub-area: One-line diagram

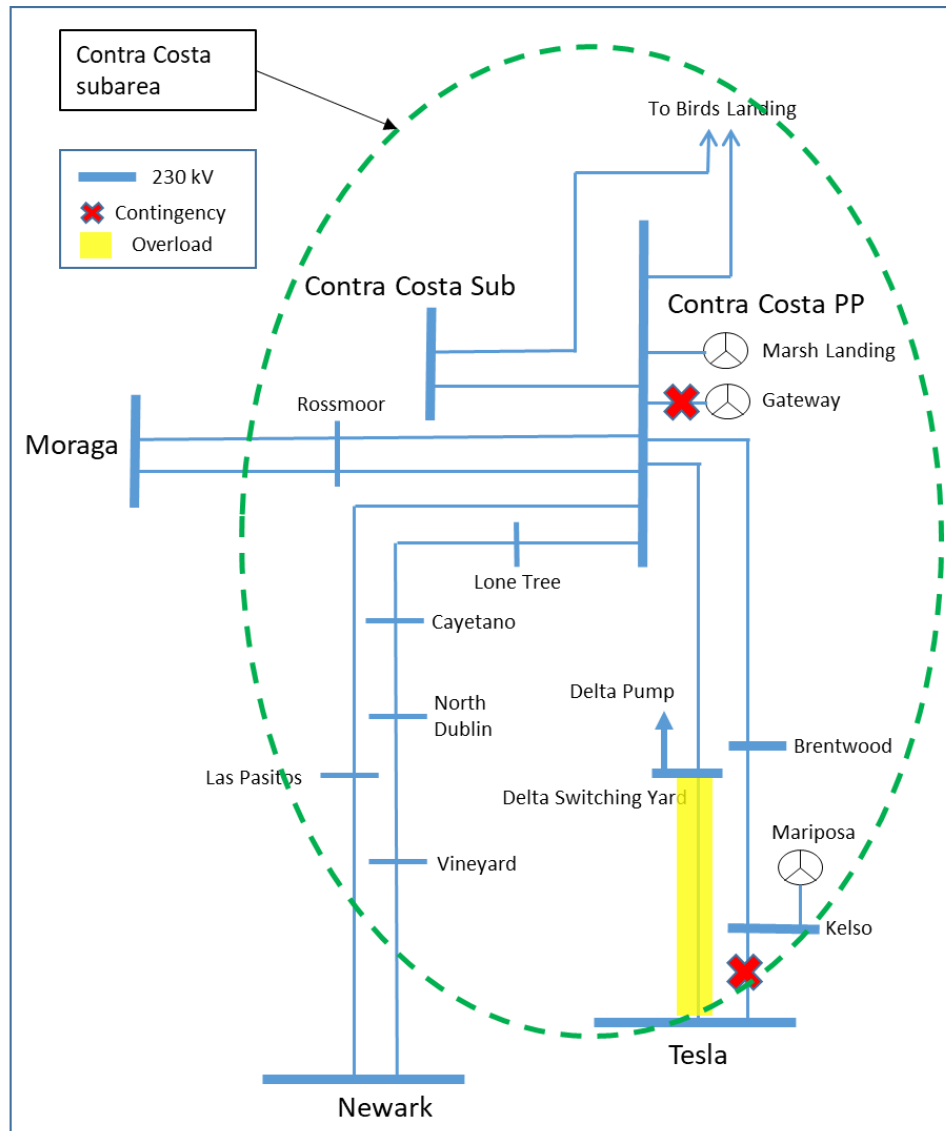

Contra Costa Sub-area: Requirements

Year	Category	Limiting Facility	Contingency	LCR (MW) (Deficiency)
2022	P3	Delta Switching Yard-Tesla 230 kV Line	Kelso-Tesla 230 kV with the Gateway off line	1208
2026	P3	Delta Switching Yard-Tesla 230 kV Line	Kelso-Tesla 230 kV with the Gateway off line	1815

Greater Bay Area Overall: Load and Resources

Load (MW)	2022	2026	Generation (MW)	2022	2026
Gross Load	10,611	11364	Market/ Net Seller/ Battery/Wind	6,263	6,153
AAEE	-75	-133	Solar	8	8
Behind the meter DG	-271	-269	Existing 20-minute Demand Response	0	0
Net Load	10,264	10,960	Muni	373	373
Transmission Losses	217	327	QF	238	238
Pumps	264	264	Future preferred resource and energy storage	866	902
Load + Losses + Pumps	10,746	11,551	Total Qualifying Capacity	7,748	7,674

Greater Bay Area Overall: Requirements

Year	Category	Limiting Facility	Contingency	LCR (MW)
2022	P6	Metcalf 500/230 kV #13 transformer	Metcalf 500/230 kV #11 & #12 transformers	7231
2026	P6	Metcalf 500/230 kV #13 transformer	Metcalf 500/230 kV #11 & #12 transformers	7979 (305)

Greater Bay Area Sub-area: Load Profiles

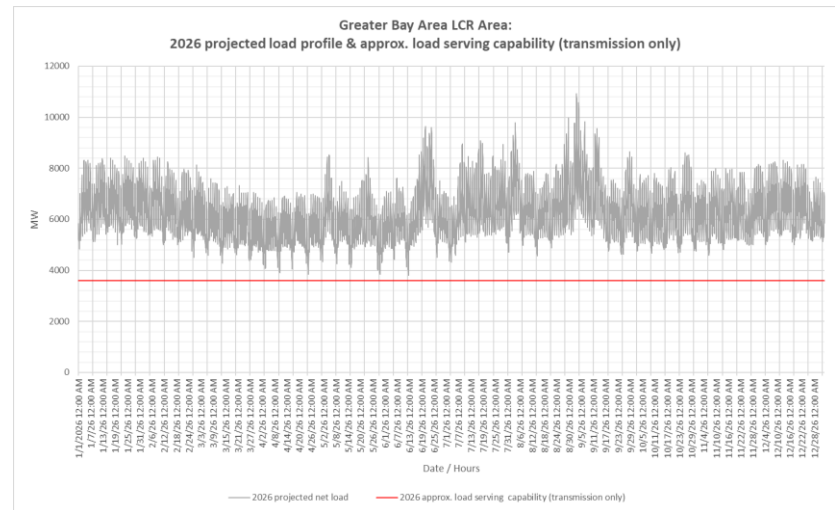
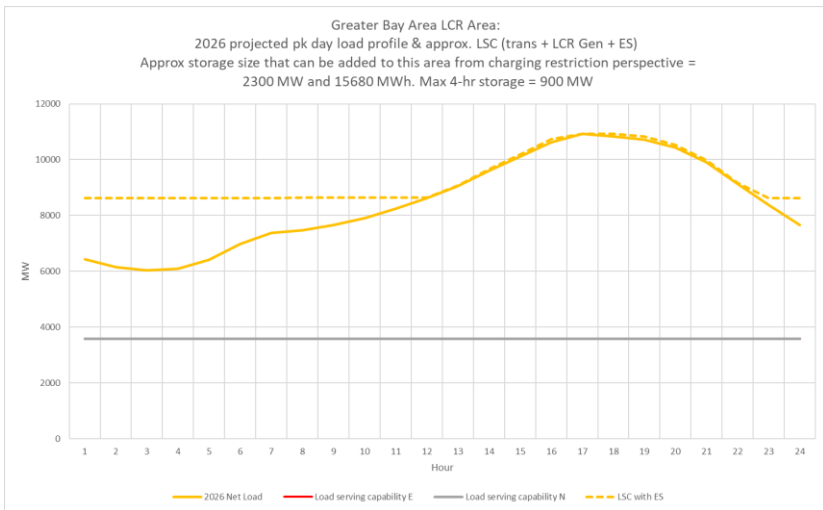
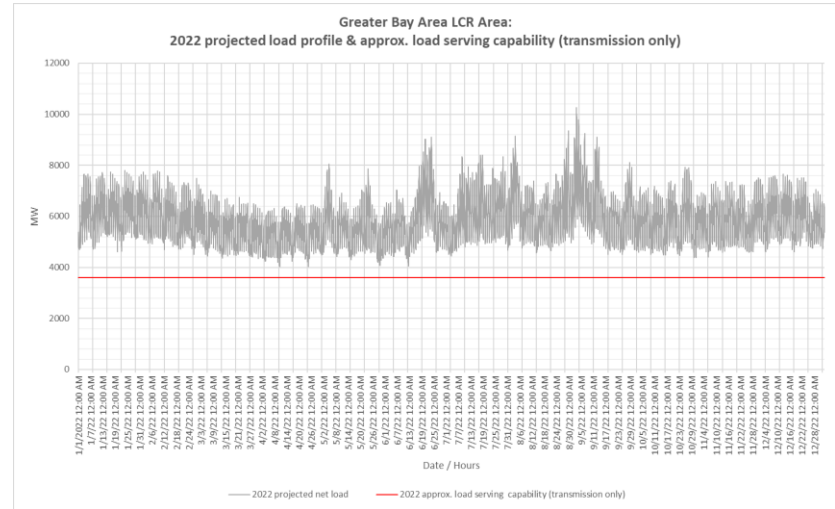
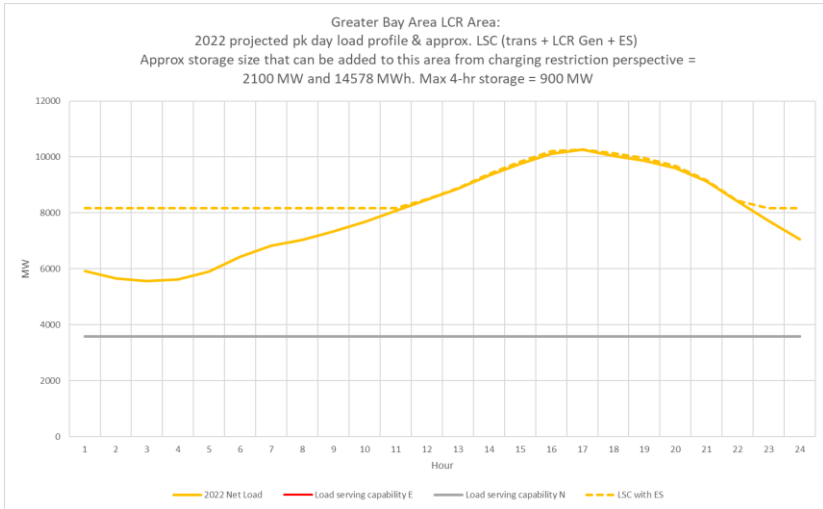

Greater Bay Area Total Generation & LCR Need

Generation	Market included Wind (MW)	20 minute Demand Response	Muni (MW)	QF (MW)	Future preferred resource and energy storage (MW)	Total MW
2022	6263	0	373	238	866	7748
2026	6153	0	373	238	902	7674

Year	Existing Generation Capacity Needed (MW)	Deficiency (MW)	Total MW Need
2022	7231	141	7372
2026	7674	305	7979

The overall LCR requirement has increased mostly due to load growth seen in the San Jose area (SVP) and it being very effective on the Metcalf 500/230 kV transformer banks. With all San Jose resources previously being used, the increased need had to be picked up by bigger amounts of less effective resources in other parts of the Bay Area.

Changes Compared to Previous Year's LCR Requirements

Sub-area	2021		2022		2025		2026	
	Load	LCR	Load	LCR	Load	LCR	Load	LCR
Llagas	199	31	188	20	201	33	196	25
San Jose	2543	793	2683	989 (141)	2527	862 (14)	3082	1096 (248)
South Bay – Moss Landing	4145	1783	4321	2333	4124	1784	4821	2535
Oakland	218	99	181	101	219	71	178	31
Pittsburg – Ames – Oakland	NA*	1967	NA*	1791	NA*	1761	NA*	1763
Contra Costa	NA*	1119	NA*	1208	NA*	1417	NA*	1815
Overall	10780	6353	10746	7231	10743	6110	11551	7979 (305)

Note:

* Flow-through area. No defined load pocket.